

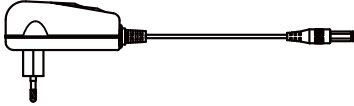



Art.-Nr.: 706.96  
706.97  
709.09

PLIR 07/18



709.09: 1,5m  
706.96: 3m  
706.97: 4,8m

1x  1x  1x  1x 

**A**

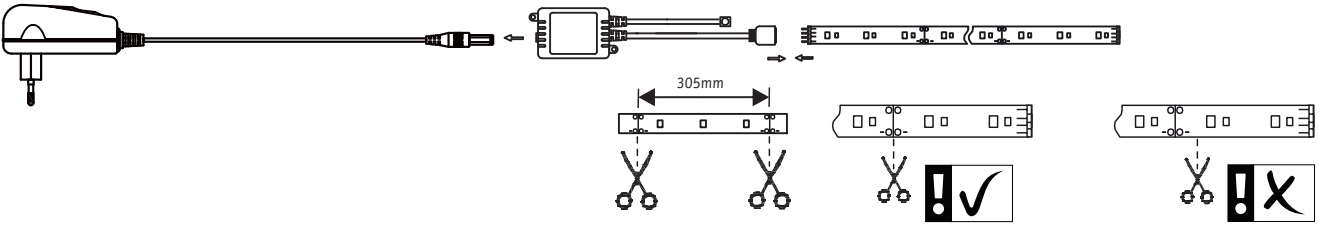
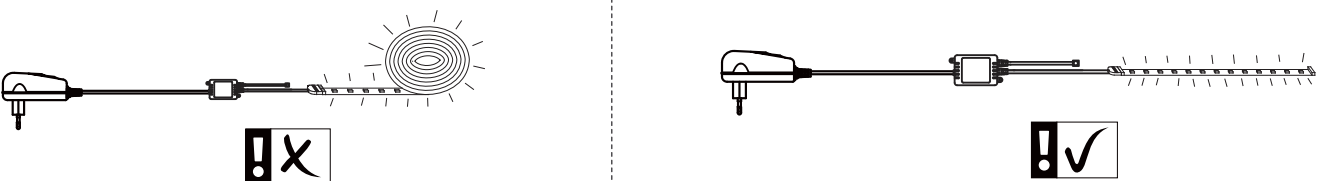
**B**



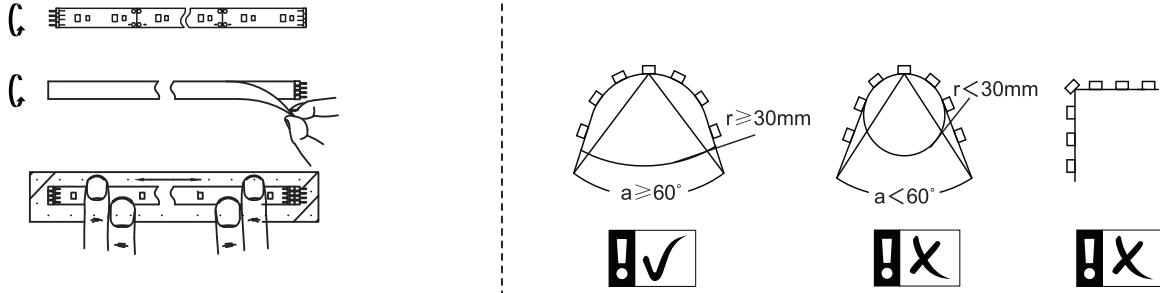

**C**

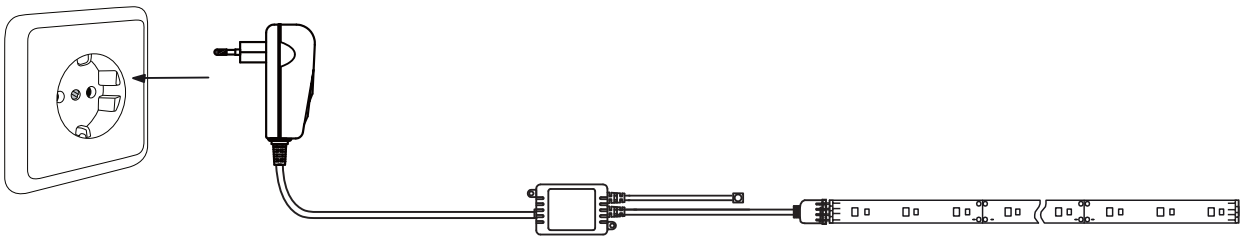

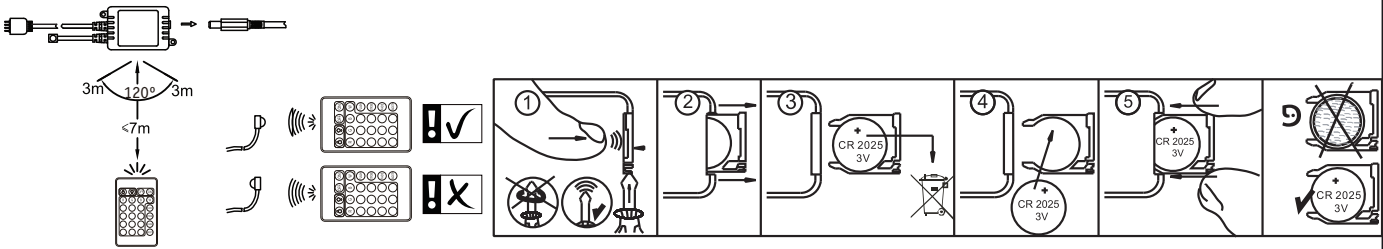
**D**

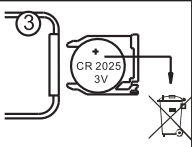
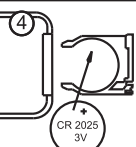
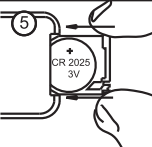
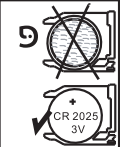

3m 120° 3m  
<7m

1  2  3  4  5  6 

CR 2025 3V



Paulmann



[www.paulmann.com/manual-digled/all](http://www.paulmann.com/manual-digled/all)



**Static Light effects:**  
dimming brightness up  
**Dynamic Light effects:**  
increases speed of light effect  
**IC number setting:**  
reactivates unlighted stripe segments



WWW shift key, 3000K



IC number setting / electronic cutting



flow to centre from two terminals  
(CS,C3,C7,C 16)



eight-color choice key in static model



Trail into right (CS,C3,C7,C16)



three-color choice key in static model



Horse race to right direction (CS,C3,C7,C16)



seven-color choice key in static model



spread to right (CS,C3,C7,C1 6)



sixteen-color choice key in static model



Queued color running to right with a tag  
(CS,C3,C7,C1 6)



**Static Light effects:**  
dimming brightness down  
**Dynamic Light effects:**  
slows down speed of light effect  
**IC number setting:**  
deactivates last stripe segments



ON/OFF key



flow to two terminals from centre  
(CS,C3,C7,C1 6)



Auto-cycle mode



Trail into left (CS,C3,C7,C16)



Trail from two directions in turn



Horse race to left direction (CS,C3,C7,C16)



Flash function key (CS,C3,C7,C16)



spread to left (CS,C3,C7,C1 6)



Jump efficient key (CS,C3,C7,C1 6)



Queued color running to left with a tag  
(CS,C3,C7,C1 6)



Queued color running with a tag from two  
directions in turn



IC number setting / electronic cutting

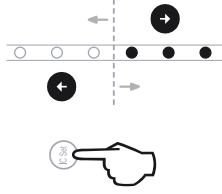
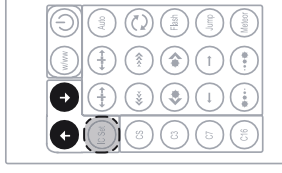
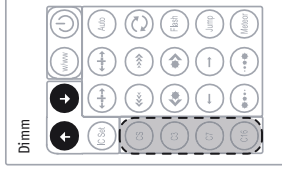

### Light effects

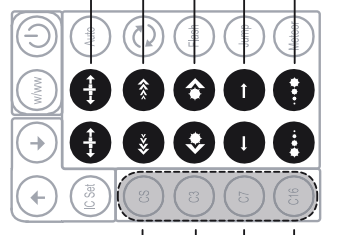

Choose color

3 color

7 color

16 color

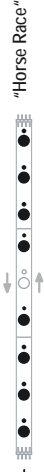

### Mix of all effects

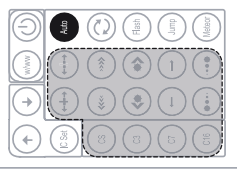

### Mix of

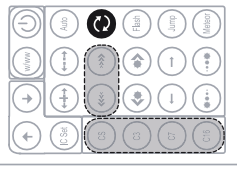

### Fade

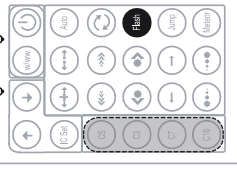

### Color jump

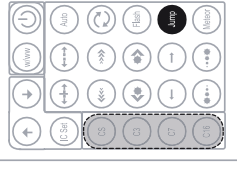

### Mix of

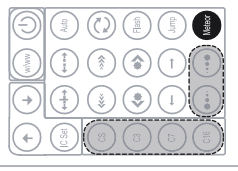

### Speed

